

Gasket & Seal Products

Immersed Tunnel Gasket | Segment Seal | Grout Seal |
Super Rubber Seal | Customized Rubber Seal | Other Products

DRB

DRB provides diverse rubber related products such as Power Transmission Belt, Conveyor Belt & System, Rubber Track & Undercarriage System, Construction Materials, Seismic Isolation & Vibration Control. With experience gained from more than 65 years of tradition and history, DRB will always work for its customers worldwide.



Head office and Plant



Yangsan Plant



DRB China



DRB Slovakia



DRB Vietnam



DRB America



DRB Japan

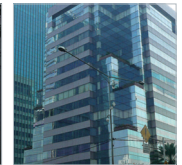

DRB Indonesia

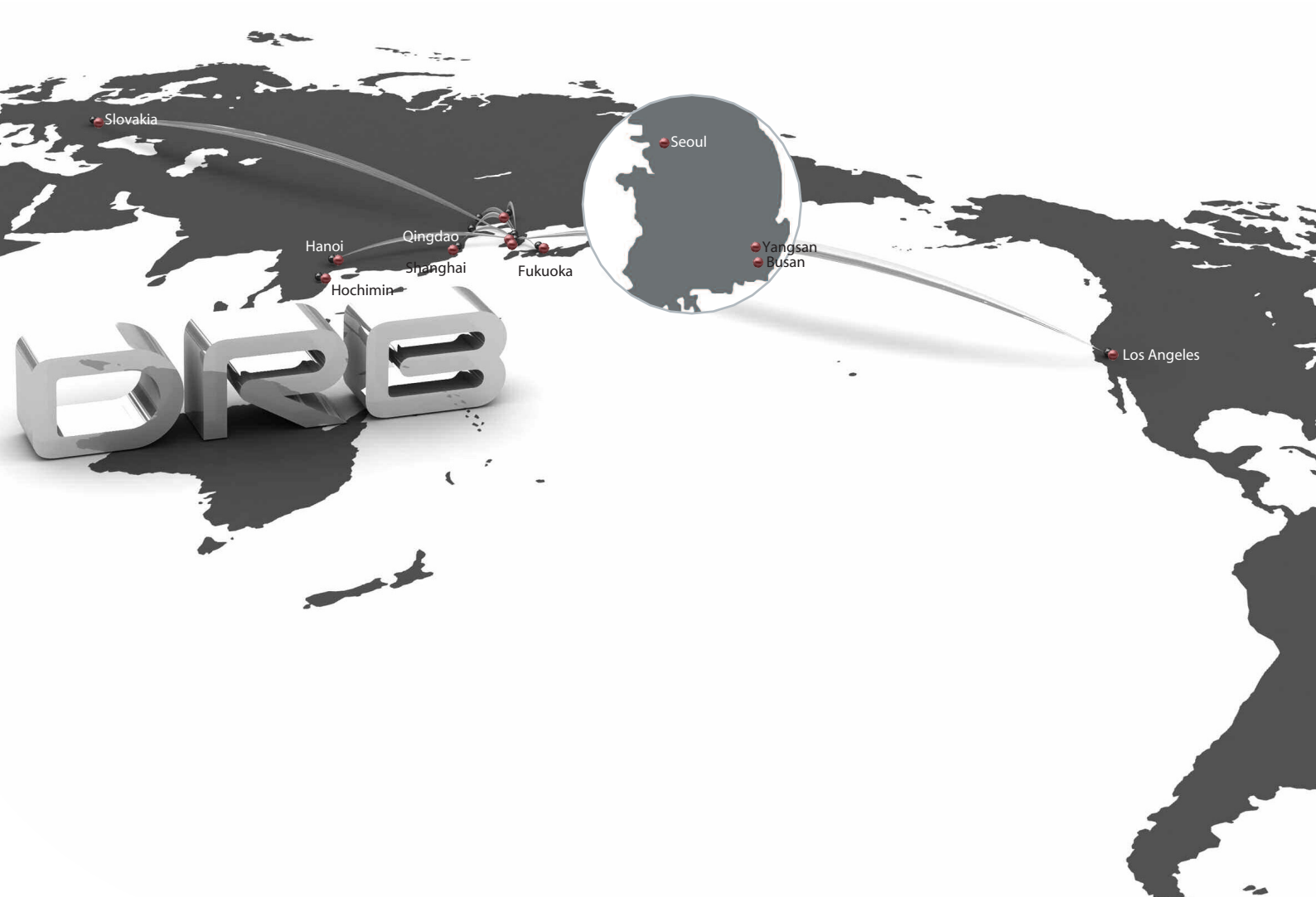

Corporate History

1945	Established Dongil Chemical Works
1966	Incorporated as Dongil Rubber Belt Co., Ltd.
1967	Joint development of vehicular Rubber Products with Hundai Motors
1976	Stock exchanged in Korea Stock Market
1986	Established R&D Center
1987	Started Factory Automation Business
1989	Obtained the Certification of KS Standard for Rubber Fender
1991	Obtained the Certification of KS Standard for Bridge Rubber Bearing Pad
1993	Technical Cooperation with SONNEVILLE INT'L. CORP(Low Vibration System Track)
1995	Obtained ISO9002 (KSA-QA) Certification
1996	Developed Anti-vibration Pad for rail road tracks
1997	Installed Rubber barricade on Dokdo island
2001	Completed implementation of ERP system
2001	Established Qingdao Dongil Rubber Belt Co., Ltd. in China
2003	Recertified from ISO9002 to ISO9001
2003	“The structure jointing method of Safety guard” Patent application
2004	Established Dongil Rubber Belt North America Inc.
2004	Developed PGF for Subways
2004	Obtained ISO14001(environmental) Certification
2005	Established Dongil Rubber Belt Beijing Co., Ltd. in China
2006	Established Dongil Rubber Belt Vietnam Co., Ltd.
2006	Established Hanoi office in Vietnam
2007	Obtained Japan NRB Certification
2008	Established Dongil Rubber Belt Japan Co., Ltd.
2009	Built Vietnam plant
2010	2010 Built Qingdao Dongil Culture Center

Contents

*

04	Immersed Tunnel Gasket
06	Segment Seal
07	Grout Seal
08	Super Rubber Seal
09	Customized Rubber Seal
10	Other Products
13	ETC

*

Immersed Tunnel Gasket



DRB's Immersed tunnel gasket is installed to the sectional elements of immersed tunnels to prevent water ingress due to external water pressure

Drawing & Dimension

- Immersed Tunnel Gasket

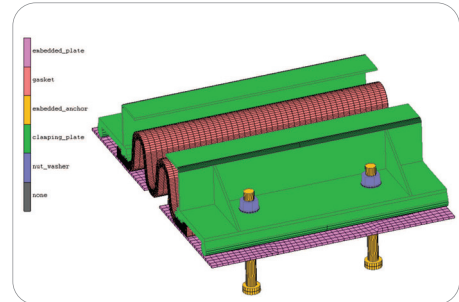
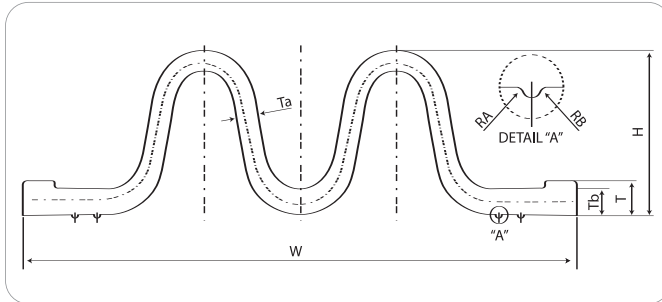

Fatigue Simulation

※ We can manufacture various seal size & grade of seal.
Please consult DRB to get size & grade information.

Installation section of gasket

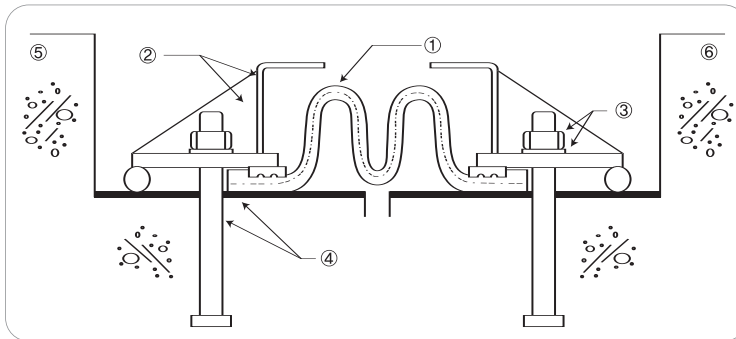

NO	Designation	Material	Remarks
1	Immersed tun	Rubber+ Reinforcement fabric	-
2	Clamping plate	STS304 or STS316L	-
3	Fixing nut, washer	STS304 or STS316L	-
4	Embedded plate	STS304 or STS316L	With welded anchor bolt
5	Immersed tunnel	Concrete	-

※ This diagram is intended as a guide only. If in doubt, please consult a DRB office

Design

- Velocity Contour

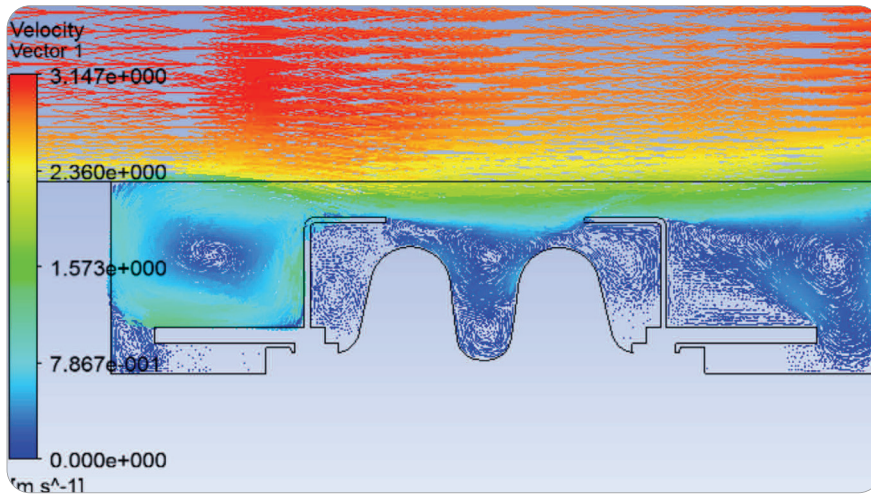

- Stress Modeling

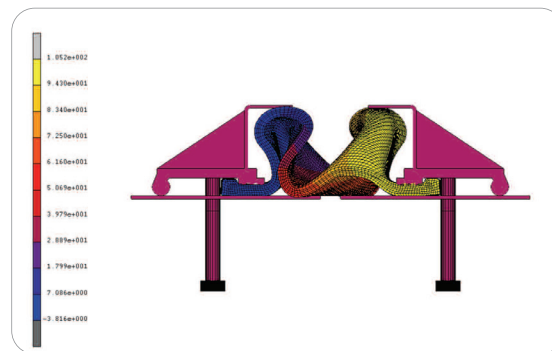
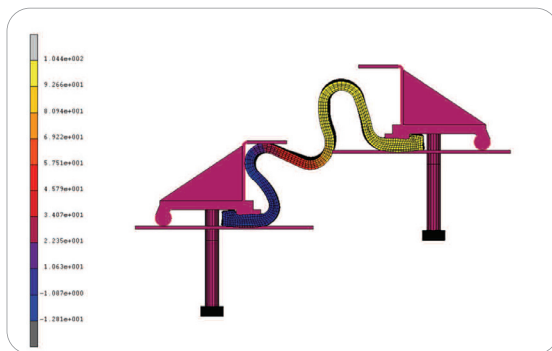
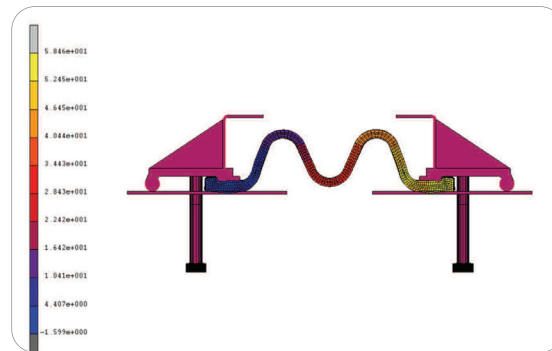
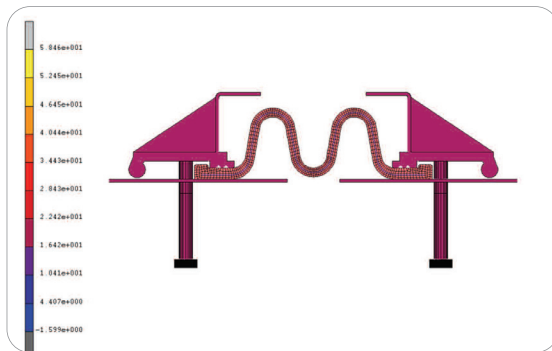



Segment Seal



DRB segment seal(DSS) has been supplied to under-sea tunnels and segmental lined of tunnels.

DSS, which are located in precast grooves encircle each segments with mating forces, give secure function of waterproof to segment.

Advantages

- DSS for tunnel segment is :
 - easy to install
 - to reduce cost
 - to assure an effective seal in wet conditions.
 - has reliability, durability, resistant to chemical attack.

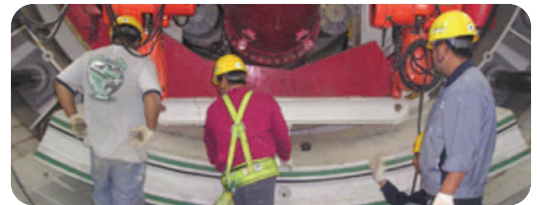

Design

• DRB manufactures a DSS designed for precast segments used in the lining of tunnels.

All of DRB products are precision engineered to meet the requirements of individual projects.

We will be able to specify the most suitable and economical DRB Sealing product with easy to install and reduce cost. In the stage of selection phase, customers are invited to DRB consulting team who will provide information and assistance with experiences to customer for the each project.



NO	Gasket	Seal	Seal
Shape			
Material	EPDM + Hydrophilic polymer rubber	Hydrophilic polymer rubber Normal rubber	Hydrophilic polymer rubber Normal rubber

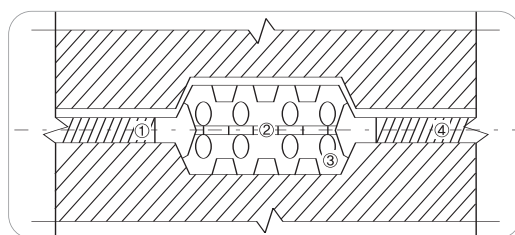

Gasket detail and circumferential joint

- ① Hydrophilic pad for segment of less than 1.4mm length
- ② Hydrophilic gasket
- ③ EPDM gasket
- ④ Packing

*

Grout Seal



DRB's grout seal(DGS) has been developed to provide grout support for structures with pre-placed pile foundations.

The DGS is used for installations where the piles are pre-driven for Monopile / Transition-Piece foundations and Jacket

Drawing & Dimension

- General Grout Seal

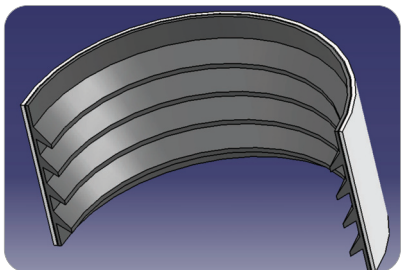
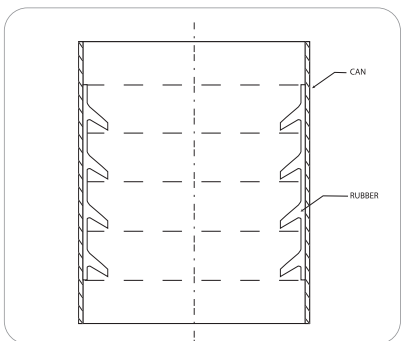

Pile Size(inches)	Pile Size(mm)	Materials
30	762	EPDM or CR
33	838.2	EPDM or CR
35	889	EPDM or CR
36	914.4	EPDM or CR
37	939.8	EPDM or CR
39	990.6	EPDM or CR
39.5	1003.2	EPDM or CR
41	1041.4	EPDM or CR
42	1066.8	EPDM or CR
45	1143	EPDM or CR
48	1219.2	EPDM or CR
51	1295.4	EPDM or CR
52	1320.8	EPDM or CR
54	1371.6	EPDM or CR
57	1447.8	EPDM or CR
63	1600.2	EPDM or CR

We can manufacture various size & grade.
Please consult DRB to get more size & grade information.

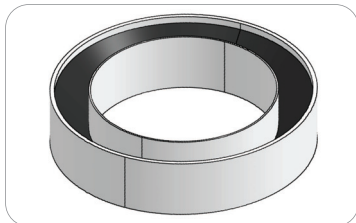
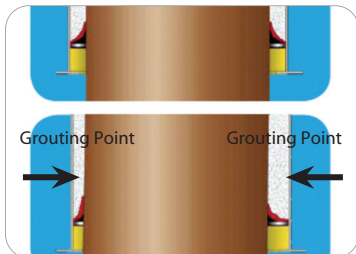
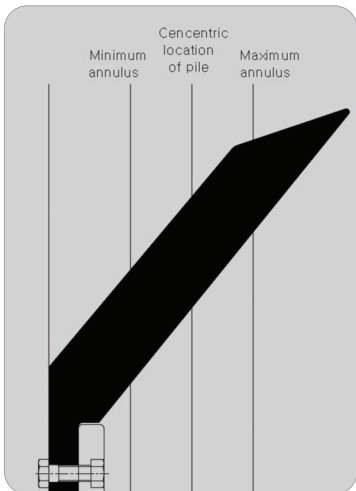

*

Super Rubber Seal



The S-Seal (& Gasket) which manufactured by DRB are widely used in not only vessel designed for deep sea construction but various equipment, tool and material. DRB provides you suitable solution for your project needs, supplies outstanding product and optimal product design which considered condition of equipment, structure, site and function.

Drawing & Dimension

- Moonpool Hatch Seal

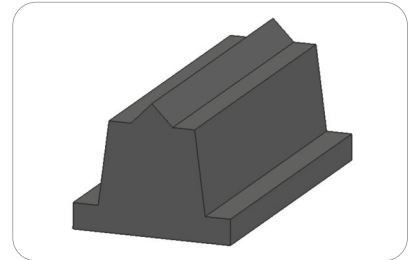
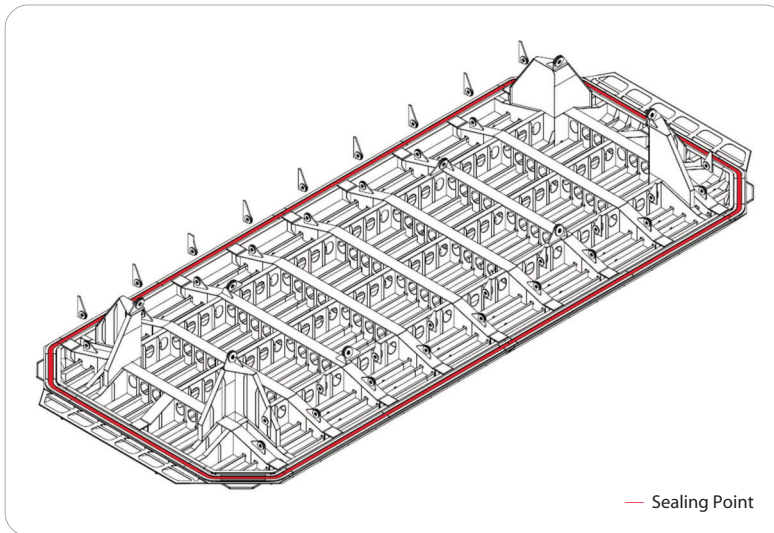

Type	Height(mm)	Length	Materials
A	100 ~ 200	Customized	CR or EPDM
B	200 ~ 300		"
C	300 ~ 400		"

We can manufacture various size & grade.
Please consult DRB to get more size & grade information.

*

Customized Rubber Seal



The Rubber Seal for water gate supplied by DRB is used in dam and movable weir for watertight. DRB provides you suitable solution for your project need, supplies outstanding product and optimal product design which considered condition of equipment, structure, site and function.

Customized Rubber Seal

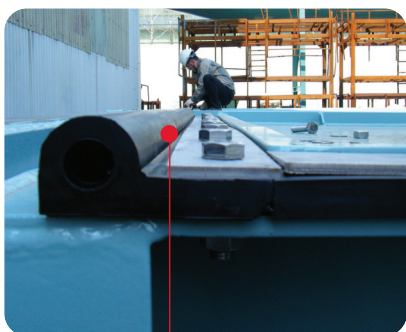

Side Seal



Bottom Seal

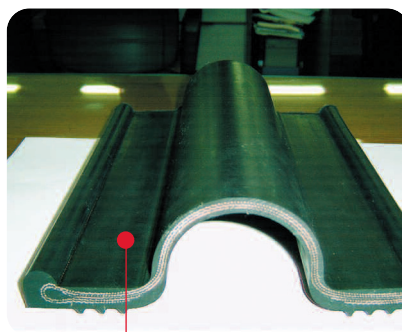

Omega Seal

- Side Seal

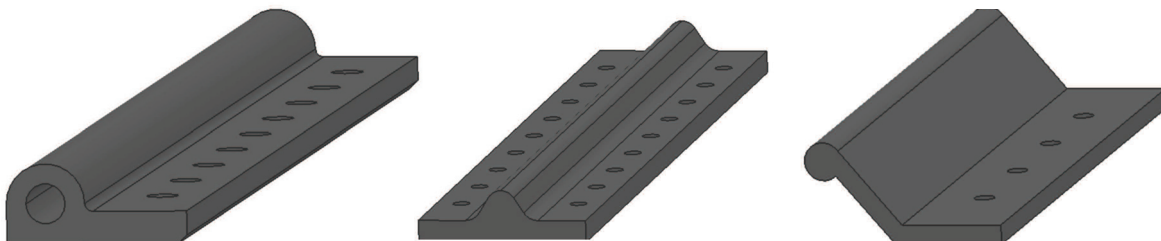

- Bottom Seal

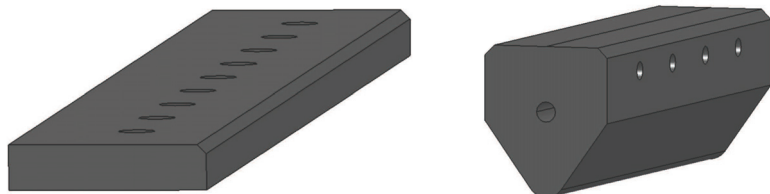

We can manufacture various size & grade.
Please consult DRB to get more size & grade information.



Other Products

Auto Cable Cover Belt



Fatigue Testing

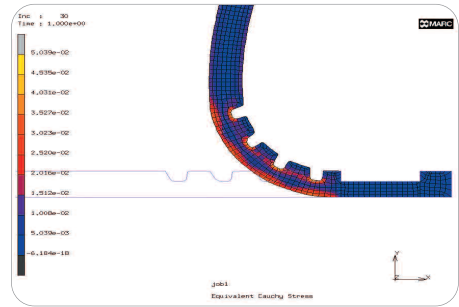

Fatigue Simulation



Fender

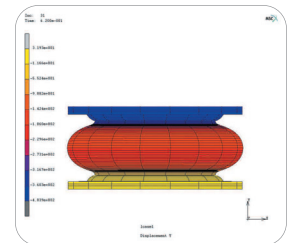
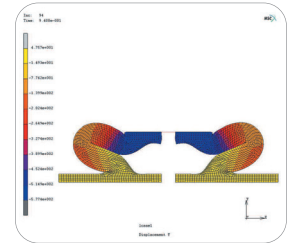

*
ETC

Eco Tank A Road Surface First Flush Treatment System

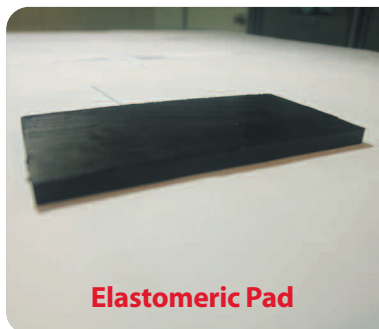
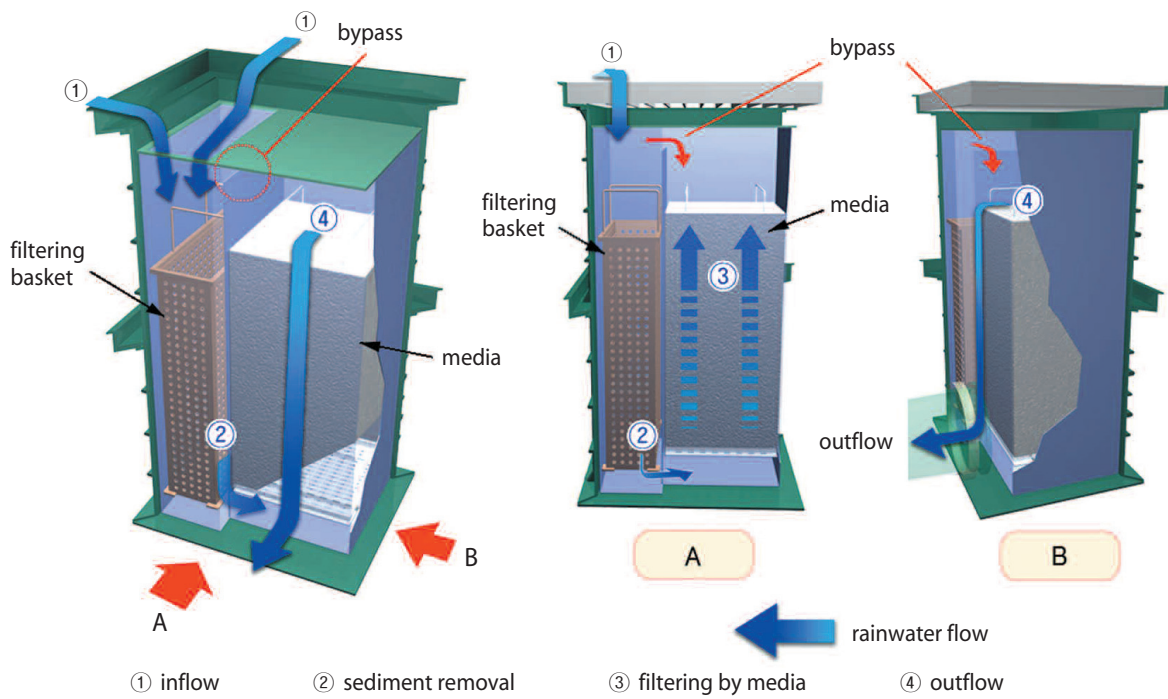



DRB Holding Co., Ltd.

Headquarters DRB

28, Gongdandong-ro 55beon-gil, Geumjeong-gu, Busan, Korea
Tel. +82-51-520-9104 Fax. +82-51-526-7722

Sales Office DRB / Constructional Materials Sales Division

26, Yeongdeungpo-ro 53-gil, Yeongdeungpo-gu, Seoul, Korea
Tel. +82-2-2168-9134 Fax. +82-2-2672-6423

DRB America

13040 Moore St. Cerritos, CA 90703, America
Toll Free. 888-860-4450 Tel. +1-562-802-3088 Fax. +1-562-802-3089

DRB Japan

7F, CR Hakata Bldg., 1-8-6, Hakataeki-minami, Hakata-ku, Fukuoka-city, 812-0016, Japan
Tel. +81-92-481-7303 Fax. +81-92-481-7307